



LOAD BEARING 120,000 LBS



ONE-MAN OPERABLE



REDUCED INFILTRATION



AUTOMATIC SURGE RELEASE



ODOR CONTROL

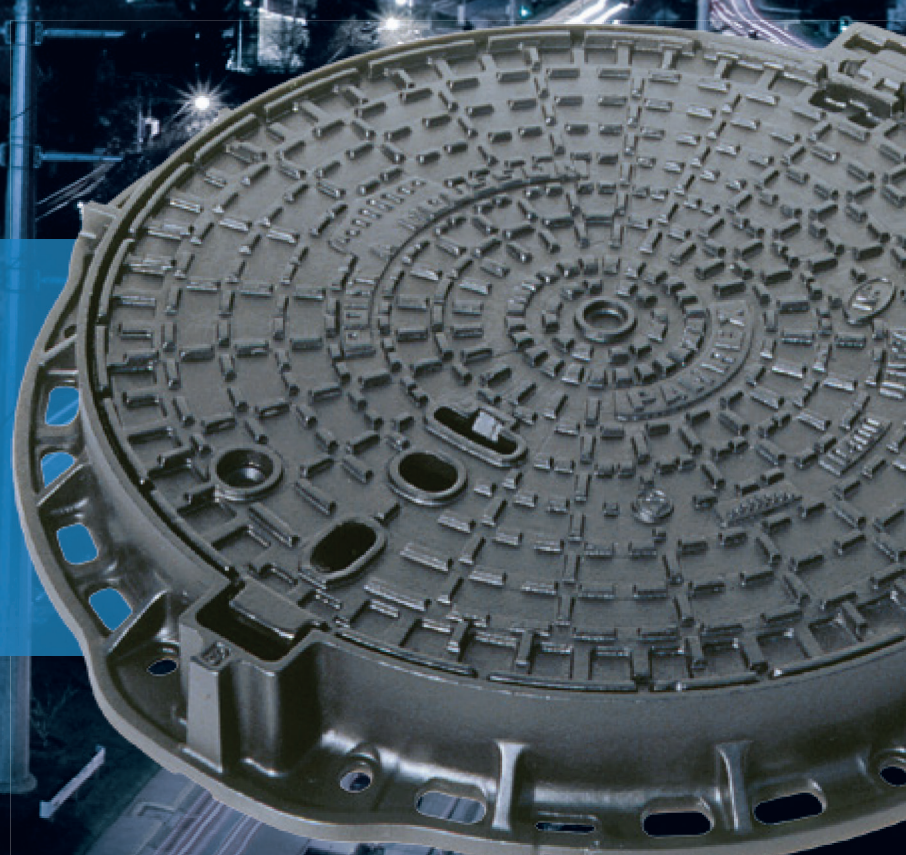

Access Covers and Gratings

# PAMREX Manhole Covers

## Safety

Protecting field personnel from the risk of injury and the below-ground networks from catastrophic failure are two of the primary concerns facing engineers and municipal administrators.

Research into compressive forces on intervertebral disks has allowed scientific assessment of the physiological restraints linked to handling loads. This research indicates that duration of lift, spinal rotation during lift, and proximity of load to the body during the lift are key risk factors for utility employees who regularly handle manhole covers.

## Ductile Iron

Ductile iron provides a superior strength-to-weight ratio, which allows up to a 50% weight savings compared to cast-iron designs.

## Design of PAMREX

- Improved ergonomics:
  - Hinges reduce the physical effort by 50%.
  - Hinges allow the operator to move in a straight line, thereby avoiding damaging spinal rotation.
  - Hinges minimize the duration of the lift; the hinge also retains the cover in a safe and controlled way during and after the lift.
  - Lifting points in the cover are designed for use with standard tools (pickaxe/hook/bar).

### INSPECTION

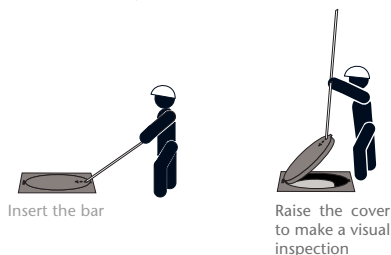

### OPENING

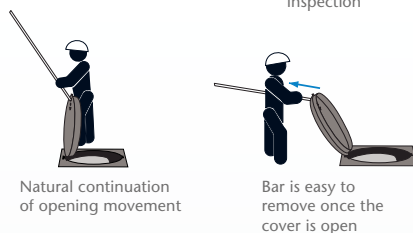

- Hinge incorporates a 90° blocking feature to prevent accidental closure. Employees must ensure that the hinge housing is kept free of debris and that the 90° blocking has properly activated before entering into the chamber.

- Self-centering design of the gasket eliminates the need to guide the cover into position when closing.
- Design of apertures ensures easy insertion and removal of tools.
- Lifting loops in the frame (above) facilitate safe offloading and installation with appropriate equipment.
- The cover is designed to open and release pressure if the sewer becomes surcharged (provided that no additional Penta or SCS lock has been fitted and that the frame has been securely anchored to the top of the chimney).
- The cover can be removed if required.

## Strength

- PAMREX is capable of withstanding an average load of 120,000 lbs. This is much greater than the AASHTO (American Association of State Highway and Transportation Officials) H20 heavy duty loading.
- PAMREX has been independently tested by a U.S. facility.

## Stability and Durability

- Gasket rings absorb damaging traffic shock and help to prevent the breakdown of frame bedding materials. Therefore, structural failure that can lead to more serious problems like frame instability is significantly reduced. Scientific analysis has clearly shown that new gaskets absorb 64% of the shock, and even after many years of service continue to absorb over 50% of the shock.
- Gasket rings ensure cover stability regardless of traffic conditions.

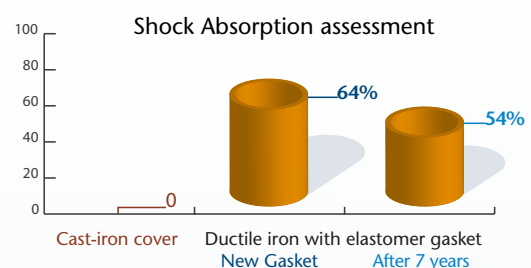

# PAMREX Anti-Theft Cover Locks

The following locking devices were designed to increase resistance to non-authorized access. It must be noted that neither of these devices will prevent the determined criminal or vandal from gaining access.

## Penta Locking Kits



- 1/4 turn lock activated by an asymmetrical fivesided bolt head.
- On-site installation takes five minutes:
  - Punch out the center of the locking bolt position.
  - Install the kit in compliance with the instructions supplied.
- Lock must be operated with the handling key supplied with the kit or separately.
- The installation of a Penta lock will not allow the cover to open under pressure when the sewer becomes surcharged.

Penta Kits for PAMREX 24" and PAMREX 28"

MODEL	REFERENCES
KIT WITH HANDLING KEY	C5
KIT WITHOUT HANDLING KEY	C6
HANDLING KEY	C17

Penta Kits for PAMREX 32"

MODEL	REFERENCES
KIT WITH HANDLING KEY	C13
KIT WITHOUT HANDLING KEY	C14
HANDLING KEY	C17



## SCS Locking Kits

- 1/4 turn lock is activated by a bolt which has a unique notched cylindrical head design; this feature improves security by ensuring that the SCS locking key can only be removed once the manhole cover has been returned to the locked position.
- The SCS key has an internal trigger-operated lug that releases the key from the head of the bolt.
  - The key can only be released once the manhole cover is locked, thus making it impossible to forget to lock the cover.
- On-site installation takes five minutes:
  - Punch out the center of the locking bolt area.
  - Install the kit in compliance with the instructions supplied.
- Requires use of the SCS key included in the complete kit.
  - The SCS key should not be used to open the covers. Covers should only be opened using standard tools and the lifting points provided.
- The installation of an SCS lock will not allow the cover to open under pressure when the sewer becomes surcharged.



SCS Kits for PAMREX 24" and PAMREX 28"

MODEL	REFERENCES
KIT WITH HANDLING KEY	C7
KIT WITHOUT HANDLING KEY	C8
HANDLING KEY	C18

SCS Kits for PAMREX 32"

MODEL	REFERENCES
KIT WITH HANDLING KEY	C15
KIT WITHOUT HANDLING KEY	C16
HANDLING KEY	C18

## Specification

- PAMREX or similar approved Manhole Cover and Frame.
- Covers and Frames shall be manufactured from Ductile Iron in accordance with ISO 1083.
- Covers shall be one-man operable using standard tools and shall be capable of withstanding an average load of 120,000 lbs.
- Covers to be hinged and incorporate a 90° blocking system to prevent accidental closure.

- Frames shall be circular and shall incorporate a seating gasket; frame depth shall not exceed 4" (24" and 28") or 5" (32").
- Frames shall be complete with dual wiper infiltration resistant hinge plugs.
- The flange shall incorporate bedding slots and bolt holes.
- All components shall be black coated.
- Product shall be manufactured in ISO 9000 certified manufacturing plants.

# The PAMREX Range

## → PAMREX 24"

Is designed to cope with any kind of traffic but remains quiet thanks to its elastomer gasket. PAMREX is a reliable manhole cover that has withstood the test of time.

- Opens to 130°, blocks at 90° when closing
- Elastomer gasket
- H20 load rated
- Infiltration plug
- Single hinge
- Lifting loops integral to frame
- Locking devices available

BADGINGS	REFERENCES	MASS (LBS.)		DIMENSIONS (IN.)		
		COVER	TOTAL	A	O	H
STANDARD (NONE)	CDPA60EH	122	195	33-1/2	24	4
SEWER	CDPA60EHSEW	122	195	33-1/2	24	4
SANITARY SEWER	CDPA60EHSSE	122	195	33-1/2	24	4
DRAIN	CDPA60EHDRA	122	195	33-1/2	24	4

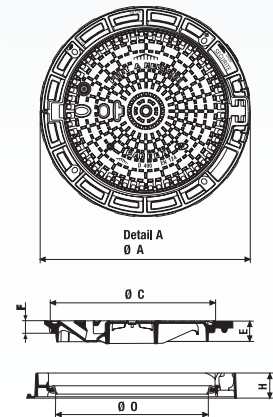

## → PAMREX 28"

Has the same functional features as PAMREX 24". Access is made through a wide 28" opening specially designed for systems requiring special safety conditions for operators.

- Opens to 130°, blocks at 90° when closing
- Elastomer gasket
- H20 load rated
- Infiltration plug
- Single hinge
- Lifting loops integral to frame
- Locking devices available

BADGINGS	REFERENCES	MASS (LBS.)		DIMENSIONS (IN.)		
		COVER	TOTAL	A	O	H
STANDARD (NONE)	CDPA70EH	158	240	37-1/2	27-1/2	4
SEWER	CDPA70EHSEW	158	240	37-1/2	27-1/2	4
SANITARY SEWER	CDPA70EHSSE	158	240	37-1/2	27-1/2	4
DRAIN	CDPA70EHDRA	158	240	37-1/2	27-1/2	4

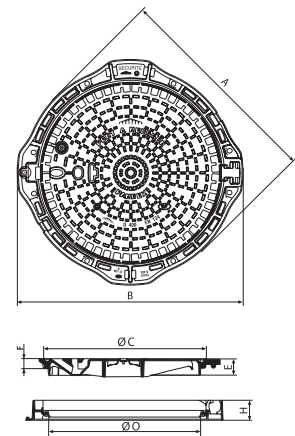

## → PAMREX 32"

Provides easy opening, while continuing to offer the high performance levels of the successful PAMREX 24" and 28" clear opening designs. The 32" clear opening enables maintenance personnel to enter the manhole with their safety equipment, or to lower bulky equipment into the below-ground network.

*Gas-arm for assisted opening and closing can be installed in plant only. Please consult your sales representative.*

- Opens to 130°, blocks at 90° when closing
- Elastomer gasket
- H20 load rated
- Infiltration plug
- Double hinge
- Lifting loops integral to frame
- Locking devices

BADGINGS	REFERENCES	MASS (LBS.)		DIMENSIONS (IN.)		
		COVER	TOTAL	A	O	H
STANDARD (NONE)	CDPA80EH	162	269	39-1/2	31-1/2	5
SEWER	CDPA80EHSEW	162	269	39-1/2	31-1/2	5
SANITARY SEWER	CDPA80EHSSE	162	269	39-1/2	31-1/2	5
DRAIN	CDPA80EHDRA	162	269	39-1/2	31-1/2	5

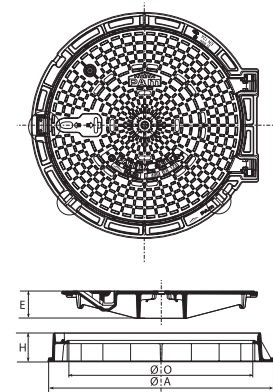

## → PAMREX 36"

Designed to enable easy access to large manhole openings, the new unit features a unique dual-hinge design and a gas arm strut. Manufactured from high-strength lightweight ductile iron, the unit maintains all of the performance levels you've come to expect from the original PAMREX range. The dramatic reduction in weight as compared to traditional cast iron, and the easy handling provided by this design, finally solves the access problem faced by utility operators and maintenance personnel, who would ordinarily require specialty equipment to open and enter large manholes. Easy access: Wide opening (36" clear) enables easy access.

- High strength
- Ergonomic advantage
- Safe
- Infiltration resistant
- Silent
- Stable
- Security
- Retrofit-badge

MASS (LBS.)		DIMENSIONS (IN.)		
COVER	TOTAL	A	O	H
205	393	48"	36"	6"

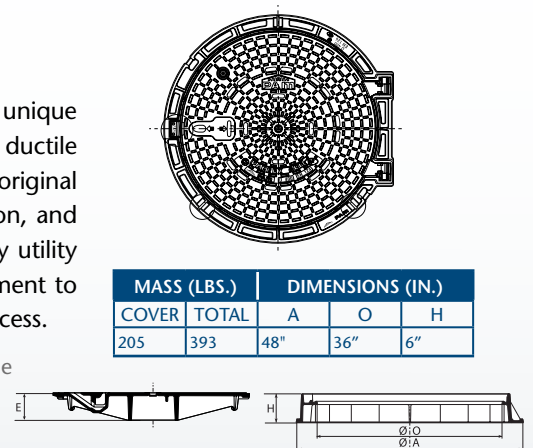

# PAMREX Manhole Covers

Designed to handle the rigors of modern traffic conditions, PAMREX, with an average load-bearing strength of 120,000 lbs, is capable of withstanding loads much greater than the AASHTO H20 requirement.

Furthermore, this superior performance is achieved in silence thanks to PAMREX's unique elastomer gasket. More recent enhancements include improved ergonomic and security features.

There are over 6 million PAM units in the ground around the world utilizing technically advanced materials and engineering. Our focus on the needs of the end-user — rather than developing products merely to meet a minimum performance standard — led us to ductile iron, a superior alternative to cast iron in terms of weight, strength and designability.



## Highlights

- Ductile iron
- Available in 24", 28" and 32" opening
- Hinged cover
- Optional locking features
- Independently tested and certified

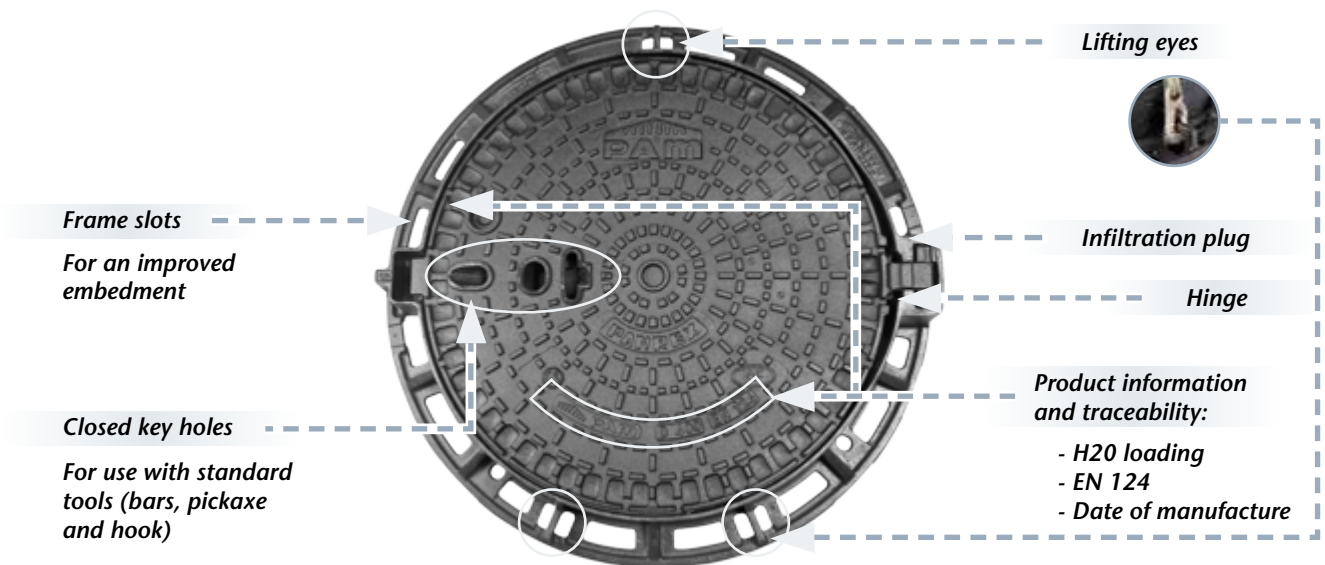

## Infiltration

To dramatically reduce the amount of surface water entering the sewer system, PAMREX covers feature an innovative plug for the hinge housing.

The "dual wiper" plug reduces the amount of water entering the network while at the same time enabling debris to be easily removed from the hinge housing.

- The factory fitted plug (near right) is standard on all PAMREX 24", 28" and 32" covers.

- Each PAMREX cover fitted with a plug is identified by means of a sticker (below right).





Central Office  
Praia de Botafogo, 440, 7th floor  
Rio de Janeiro - RJ - Brazil  
Tel: +55 21 2128-1600

São Paulo Branch  
Av. Nicolas Boer, 399, sala 03-125  
São Paulo - SP - Brazil  
Tel: +55 11 2246-7960

[pamsac@saint-gobain.com](mailto:pamsac@saint-gobain.com)

Access:  
[www.sgpam.com.br](http://www.sgpam.com.br)



Saint-Gobain Canalização